



PLANET
LIGHTING

DATASHEET

PLANET
LED PUCK
AIR SURFACE
Surface Mounted Luminaire

Minimal Footprint
Maximum Performance

Explore endless lighting potential with the groundbreaking Planet LED Puck Air, now available in a discreet surface-mounted design.

Air Surface's unique technology offers the smallest surface mounting footprint for a light of its output. Preserve the integrity of the surface and your design while effortlessly delivering maximum output and pinpoint lighting accuracy.

Discreetly positioned vertically or horizontally on any surface including masonry, steel, timber, Gyprock, and ceiling tiles, Air Surface brings a breath of fresh air to any lighting project.



AIR SURFACE

Planet LED Puck Air Surface gives designers and engineers unparalleled aesthetic discretion and precise lighting control without compromising performance or surface integrity.

With its innovative design and versatile mounting options, Air Surface seamlessly integrates into any environment. Minimise disruption while maximising versatility, output, and accuracy.

Discover limitless applications across diverse sectors, including high-end retail, captivating displays, immersive galleries and museums, and beyond.

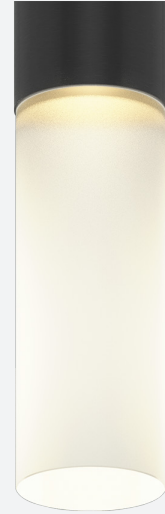

SPECIFICATIONS*



ETLus conforms to UL2108
cETL conforms to CSA C22.2 #250.0



Technical

8W
3 Step MacAdam Ellipse
L90 B10 >100,000h
CRI 80+ (CRI 90+ option)

Performance

Up to 850lm (8W @ 4000k over 100lm/w)

Optics

Polycarbonate / PMMA

Distribution

Available in a range of distributions:
(Listed on page 5)

Emitter Options

3-step bins, 2200K-5700K CCT
Tunable White, RGBW and 17 colour options

Material

Marine Grade Aluminium

Finishes

Anodised Black Matte (Standard)
Lens Ring Colour Options Available

Ambient Operating Conditions

Min. -40°C / Max. 55°C

Protection Class

IP67 / IK10

Electrical

24VDC

Installation

Ø55mm cut out

Control

0-10 v | DALI | Phase | Casambi

Dimensions & Weight

Ø25mm x 150mm (standard body)
100g per luminaire (standard body)
See options and mounts for details



Spring and screw mount options

Engineer the experience
with Air Surface.



*Specifications are subject to change without notice.

DATASHEET

AIR SURFACE

02 planetlighting.com/product/led-puck-air-surface/

PLANET
LED PUCK

ver. 28012026



PLANET
LIGHTING

BODY OPTIONS

Get creative with Planet LED Puck Air's clever family of options.

Choose either Standard, Axis or Pendant body type, then select your distribution, emitter and options. Interchangeable accessories and options are also available.

Note, final dimensions will depend on which options are chosen.

Standard body

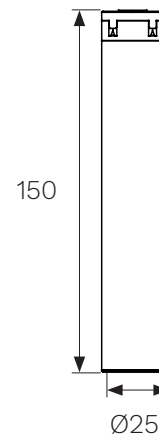

Axis body

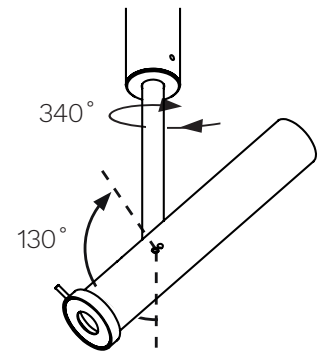

Pendant body

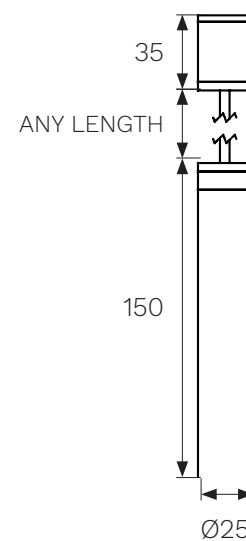

Tiltable wall mount accessory

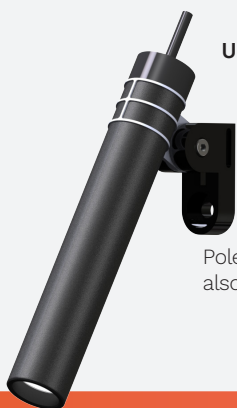

Up to 180°

Pole mounting options also available

New Air Projector Accessory!

Use our economical wall and pole mounting accessory Air Projector with any Air body.

MOUNT OPTIONS

Air Surface is available in spring and screw mount options.

Spring mount



Spring mount with round base

Screw mount

Available in round or square base

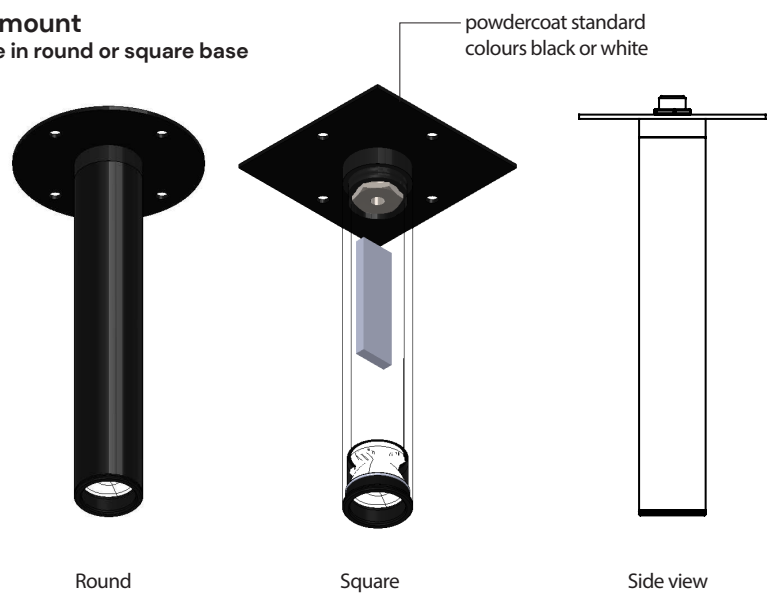

Round

Square

Side view

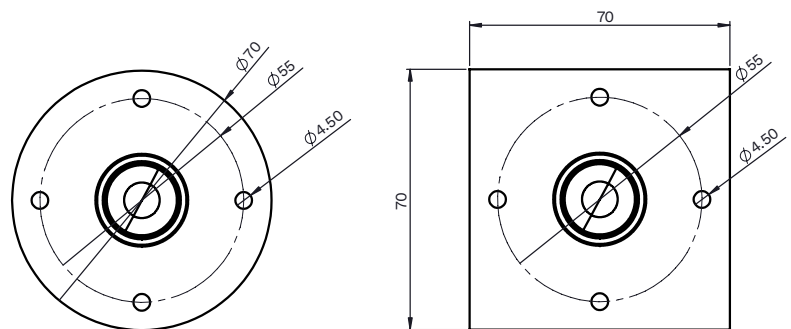

Bottom view round (left) and square (right) 4 hole pattern for screw mount

Not to scale
Dimensions in mm

PHOTOMETRICS

Available in a range of distribution options from our Air family.

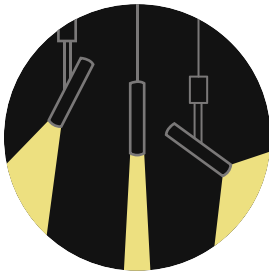

Air Director

Precise, high uniformity and limitless flexibility, our Air Director series lets you sculpt with light with incredible control.

Air Spots

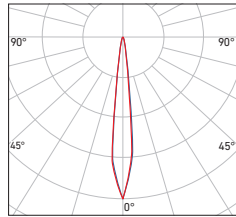

Spot

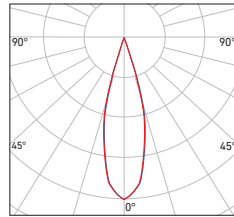

Narrow

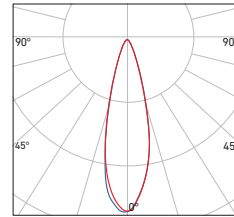

Medium

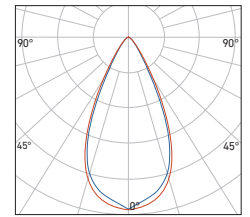

Wide

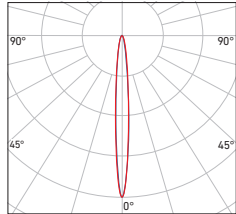

Snoot

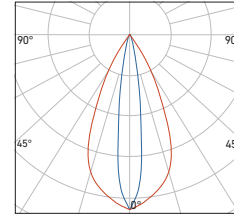

Oval

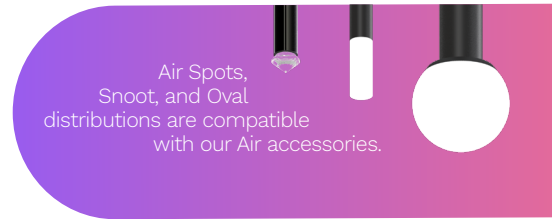

Air Floods

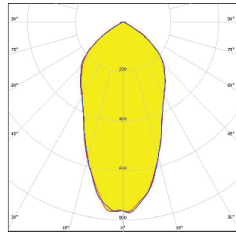

Flood Narrow

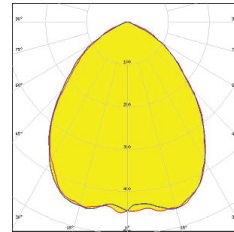

Flood Medium

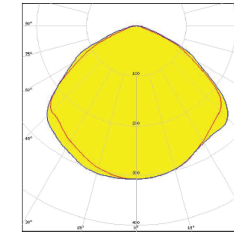

Flood Wide

Air Batwings

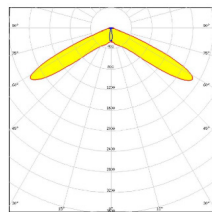

Batwing Line

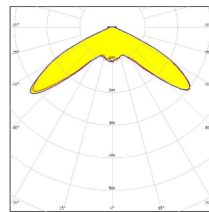

Batwing Square

Air Street

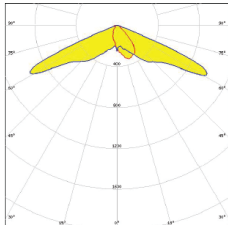

T1

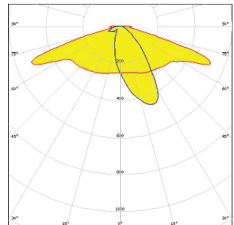

T2

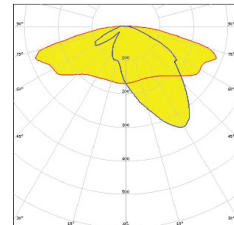

T3

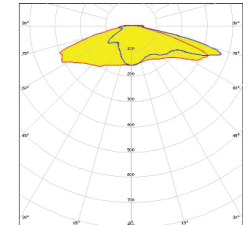

T4

New Asymmetric Range: Air Street!

Our new asymmetric options are optimised for road and path lighting. Air Street enables extremely wide spacings while maintaining great uniformity and light levels.



PHOTOMETRICS

Available in a range of distribution options from our Air family.

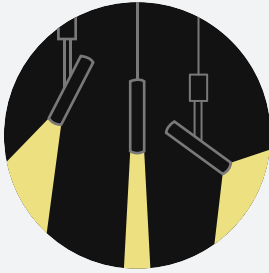

Air Director

Precise, high uniformity and limitless flexibility, our Air Director series lets you sculpt with light with incredible control.

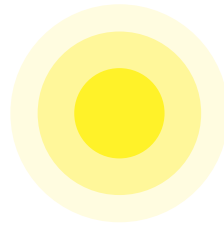

Air Zoom

Flexible focus beam adjustment from narrow to wide (~10° to 60°)

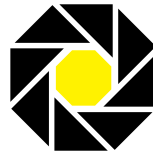

Air Iris

Adjustable beam limiter from narrow to wide

Special beams Air Zoom (top right) and Air Iris (bottom right)

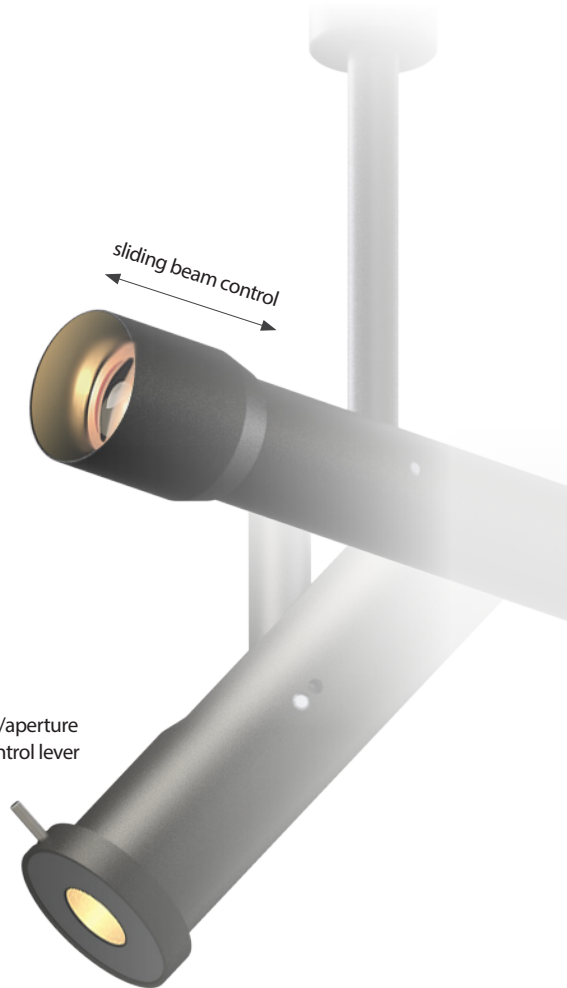

PHOTOMETRICS

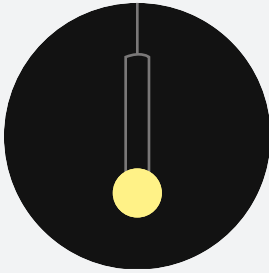

Air Brilliant

Decorative and diffuse distribution options to set the mood and ambience.



DISTRIBUTION		DESCRIPTION
Air Diamond		Cut glass with high refractive effect producing a distinct star-shaped pattern and bright centre point
Air Prism		Cut glass with a soft yet defined kaleidoscope effect
Air Wand		Modern festoon dual lighting effect
Air Globe		Modern festoon lantern. Choose from Globe Closed, Globe Open, Globe Half, Globe Silver, Globe Frosted or Globe Glass.

LED OPTIONS

Available in a range of white options (2200K-5700K CCT), Tunable White, or RGBW. Also available in 17 colours.

	2200K (22)		4000K (40)		Tunable White (TW)
	2700K (27)		5000K (50)		RGBW (RGBW)
	3000K (30)		5700K (57)		
	3500K (35)				









White WT Cool					White WT Neutral	White WT Warm	PhotoRed HR 650-670nm
Violet VL 400-420nm	RoyalBlue RY 450-460nm	Blue BL 460-475nm	Cyan CY 490-510nm	Green GR 520-535nm	Amber AM 585-595nm	Red-Orange RO 610-620nm	Red RD 620-630nm
		Phosphor PB Blue	Phosphor PC Cyan	Phosphor PL Lime	Phosphor PA Amber	Phosphor PO Red-Orange	Phosphor PR Red
				Phosphor PM Mint	Phosphor PY Yellow		



ACCESSORIES, FINISHES & EXTRA OPTIONS

Choose your finish, accessories and any additional options. LED Puck Air Surface comes standard in anodised black marine grade aluminium with matching lens ring.

Please note: Air Batwings, Air Floods and Air Street distributions are not compatible with Air accessories

FINISH / ACCESSORY		DESCRIPTION
Black Matte Body (Standard)		Anodised standard black marine grade aluminium
Black Lens Ring Finish (Standard)		Standard black lens ring finish
Gold Lens Ring Finish		Gold lens ring finish
Silver Lens Ring Finish		Silver lens ring finish
Painted Finish		Painted finish (please specify or contact us)
CRI 90+		CRI90+
Barn Doors		4 door adjustable barn doors
Air Lens Cover		Polycarbonate lens cover

**Spec Your
LED Puck Air**
The Way You Want It!

SPECIFY YOUR AIR CATENARY

Customise your Planet LED Puck Air to meet your specific requirements. Refer to the sample product code and accompanying product code table provided for guidance. For more detailed information, visit our website or contact your Planet Lighting supplier.

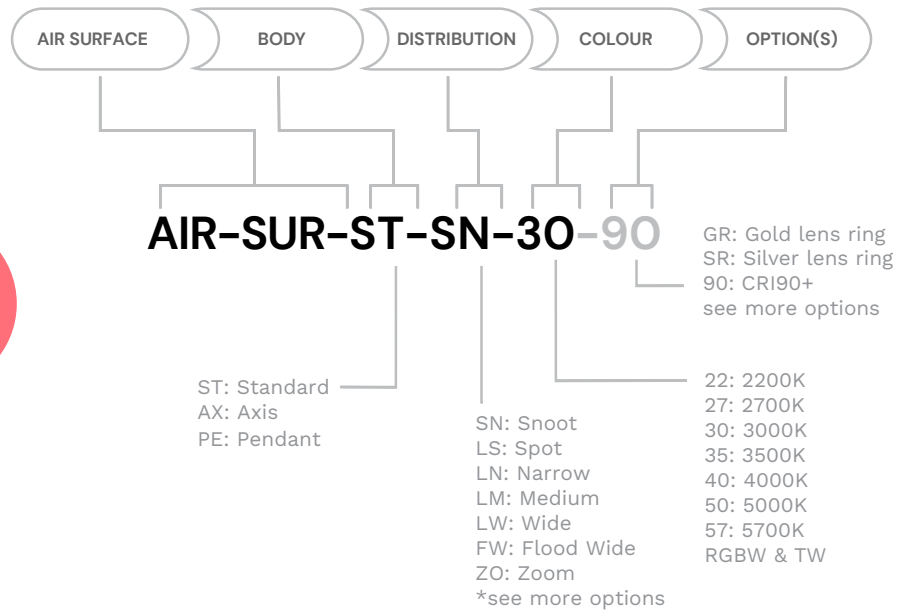

Ask Us

Your success is important to us. Get in touch with your Planet LED Puck supplier today.

PRODUCT CODES

Body

ST	Standard body
AX	Axis body (pan and tilt)
PE	Pendant body

Distribution

Air Director Range

SN	Snoot	Beam Limiter
LS	Spot	Extra Narrow Spot
LN	Narrow	Narrow Spot
LM	Medium	Medium Spot
LW	Wide	Wide Spot
FN	Flood Narrow	Narrow Flood
FM	Flood Medium	Medium Flood
FW	Flood Wide	Wide Flood
LO	Oval	Wide Elliptical

BS	Square	Batwing Square
BL	Line	Batwing Line
ZO	Zoom	Adjustable Focus
IR	Iris	Adjustable Limiter

Air Street Range

T1	T1	
T2	T2	
T3	T3	
T4	T4	

Air Brilliant Range

DI	Diamond
PR	Prism
WA	Wand
GO	Globe Open
GC	Globe Closed
GH	Globe Half
GS	Globe Silver
GF	Globe Frosted
GG	Globe Glass

Colour

22	2200K
27	2700K
30	3000K
35	3500K
40	4000K
50	5000K
57	5700K

VT	Violet
RY	Royal Blue
BL	Blue
PB	PC Blue
CY	Cyan
PC	PC Cyan
GR	Green
PM	PC Mint
PL	PC Lime
PY	PC Yellow

AM	Amber
PA	PC Amber
PO	PC Red-Orange
RO	Red-Orange
PR	PC Red
RD	Red
PH	Photo Red
RGBW	RGBW
TW	Tunable White
Custom (please enquire)	

Custom Options

GR	Gold Lens Ring Finish
SR	Silver Lens Ring Finish
P	Painted Finish (please specify)
90	CRI 90+
BD	Barn Doors
LC	Air Lens Cover

