

DATASHEET

PLANET **LED PUCK**

SNAP Tunable White

Make lighting design easy with LED Puck Tunable White. Enjoy exceptional design versatility with dynamic colour temperature and brightness control, all without sacrificing discretion. It's the Tunable White for professionals in the smallest package available.



PLANET
LIGHTING



SNAP TUNABLE WHITE

5 years warranty is just the beginning. We design and manufacture entirely in our purpose built Australian facility. Snap is vandal resistant and impact rated to IK10, and each and every Snap mini puck is burned in to ensure the light you receive performs as it should.

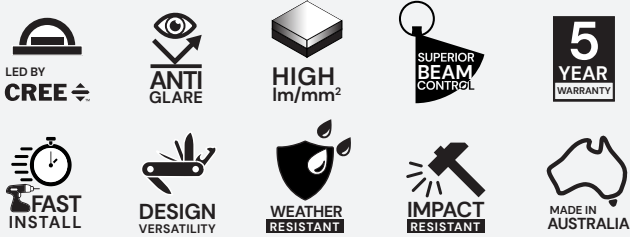
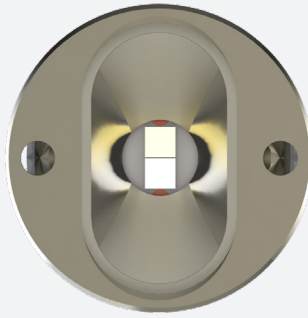

TYPICAL SPECIFICATIONS

Product Code	Specifications
SNAP-CF-ST-TW-30	SNAP Puck, Curved Face, Standard Beam, Tunable White
SNAP-FF-ST-TW-40	SNAP Puck, Flat Face, Standard Beam, Tunable White

SPECIFICATIONS*

TECHNICAL

1.4W / 500mA / 2.8Vf
 3000K - 170lm / 4000K - 180lm
 CRI 80+ (CRI 90+ OPTION)
 3 STEP MACADAM ELLIPSE
 L90 B10 >100,000h
 CCT 2700K - 6500K

OPTICS

POLYCARBONATE (STANDAP)
 BOROSILICATE (OPTION)

DISTRIBUTION

ELLIPTICAL SYMMETRIC

MATERIAL

316 STAINLESS STEEL
 ELECTROPOLISHED

AMBIENT OPERATING CONDITIONS

min. -40° / max. 55°

PROTECTION CLASS

POLYCARBONATE IP65 / IK10
 BOROSILICATE IP67 (OPTION)

ELECTRICAL

PLUG & PLAY WATERPROOF
 CONNECTOR



INSTALLATION SURFACE



MIN. 1.5mm WALL THICKNESS
 MIN. Ø35mm RAIL (CURVED FACE ONLY)



HOLE SIZE

Ø15mm



COUNTERBORE

(REQUIRED FOR FLUSH FINISH)
 Ø16mm x 1.6mm (Curved Face)
 Ø16mm x 0.5mm (Flat Face)



CONTROL

DALI2 DT8 | CUSTOM

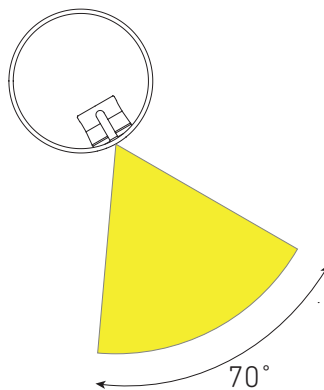

Elliptical symmetric distribution for typical mounting at 30° from vertical

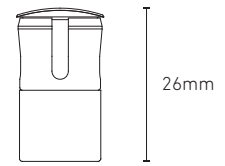
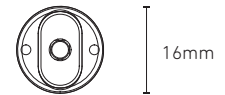

Curved Face

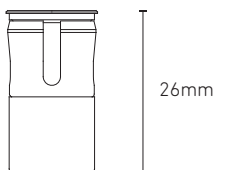

Flat Face

Ask Us.

Your success is important to us. Get in touch with your Planet LED Puck supplier today.

*Specifications are subject to change without notice.
 †Test for LED emitter at 500 mA and below 55° C ambient temp.



PHOTOMETRICS

Tunable White Standard has an elliptical symmetric distribution. For installation in handrail, mounting is typically at 30° from the vertical axis of the handrail underside. Tunable White is available in a range of distributions and special angles on request.

STANDARD BEAM 3000K

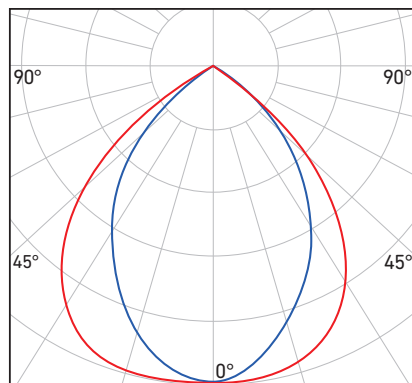

BEAM ALPHA 3000K

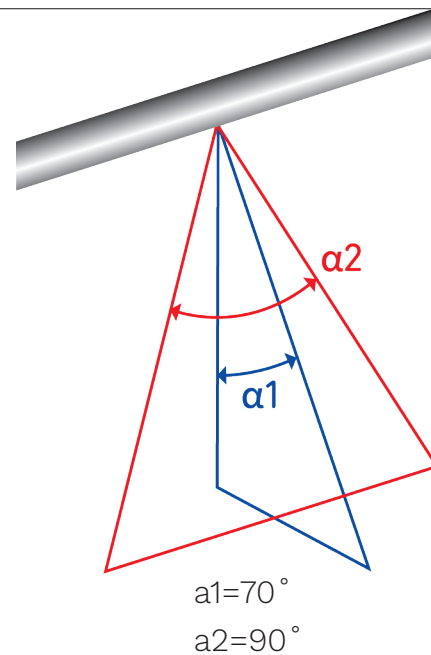

LUX GUIDE

The following guide is intended to help designers and engineers with desired lux levels. The drawing to the right shows a typical installation into a handrail. The tables list the average lux at a variety of path widths and LED spacings.

TYPICAL INSTALLATION

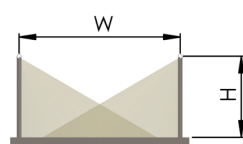

Height (H) is at 1m

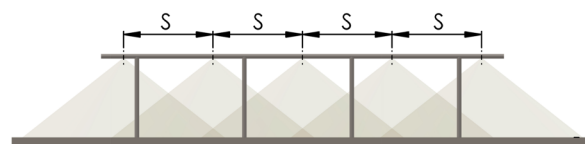

lx = average lux

CCT = 3000K

Note: Calculations indicated are with LED module installed at 30° offset from vertical down axis.

STANDARD BEAM: LIGHT FROM BOTH SIDES

Path Width (W)	1.2m	2.0m	3.0m	4.0m
LED Spacing (S)	lx	lx	lx	lx
0.5m	342	205	137	103
1.0m	171	103	68	51
2.0m	86	51	34	26

