



PLANET  
LIGHTING

DATASHEET

PLANET  
**LED PUCK**  
**AIR CATENARY**  
Compact Catenary System

**Minimal Footprint**  
**Maximum Effect**

LED Puck Air is the incredibly lightweight, highly versatile, and exceptionally elegant catenary lighting system for today's modern world. High performance yet only a fraction of the size and weight of other systems, Air enables safe, reliable, clutter-free catenary and welcomes infinite design possibilities for everything from outdoor gathering spaces to indoor accent lighting.



# AIR CATENARY

Planet LED Puck Air Catenary gives designers and engineers unparalleled aesthetic discretion and precise lighting control in a lightweight, and endlessly versatile catenary package.

With a luminaire weighing in at only 100g, Air's clever, clutter-free system maximises design options and the potential of urban and public lighting.

Discover limitless applications across indoor and outdoor applications including high-end retail, captivating displays, immersive galleries, and extraordinary outdoor spaces.

## SPECIFICATIONS\*



Intertek Intertek  
ETLus conforms to UL2108  
cETL conforms to CSA C22.2 #250.0

### Technical

8W  
3 Step MacAdam Ellipse  
L90 B10 >100,000h  
CRI 80+ (CRI 90+ option)

### Performance

Up to 850lm (8W @ 4000k over 100lm/w)

### Optics

Polycarbonate / PMMA

### Distribution

Available in a range of distributions:  
Circular, Oval, Decorative (see pages 4-6)

### Emitter Options

BINNING: 3-step bins, 2200K-5700K CCT  
Tunable White, RGBW and 17 colour options

### Material

Marine Grade Aluminium

### Finishes

Anodised Black Matte (Standard)  
Lens Ring Colour Options Available

### Ambient Operating Conditions

Min. -40°C / Max. 55°C

### Protection Class

IP67 / IK10

### Electrical

24VDC

### Installation

Ø3mm twin cable suspension (supplied by manufacturer)

### Control

GLOBAL: 0-10, DMX, RDM, DALI, Phase, Casambi;  
INDIVIDUAL: DMX, RDM, DALI, Casambi

### Dimensions & Weight

Ø25mm x Ø150mm (standard body)  
~100g per luminaire (standard body)  
See following pages.

### Cable Specifications

Single core 1.00mm<sup>2</sup> tinned copper with Kevlar braid

Engineer the experience  
with Air Catenary.



\*Specifications are subject to change without notice.



## BODY OPTIONS

Get creative with Planet LED Puck Air's clever family of options.

Choose either Standard, Axis or Pendant body type, then select your distribution, emitter and options. Interchangeable accessories and options are also available.

Note, final dimensions will depend on which options are chosen.

**Standard**  
standard body

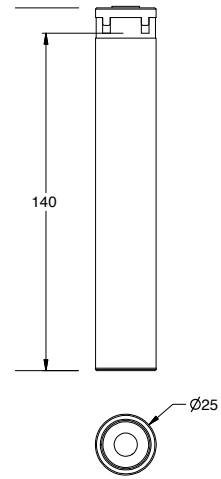
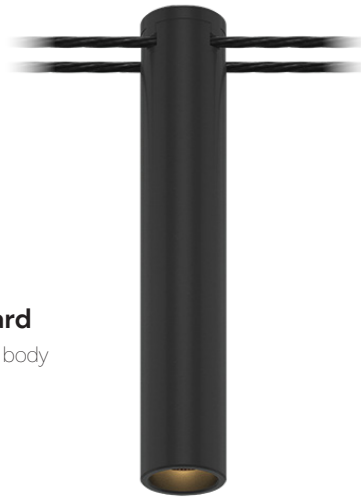

weight ~110g

**Axis**  
pan and tilt body

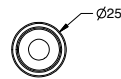
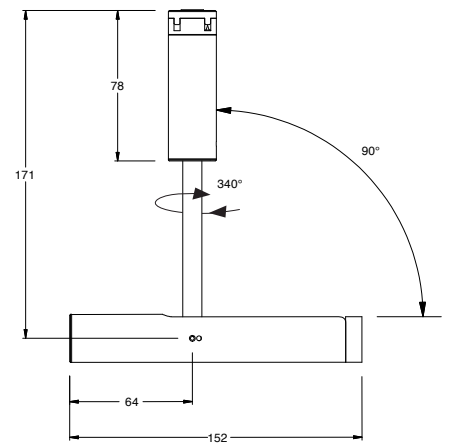
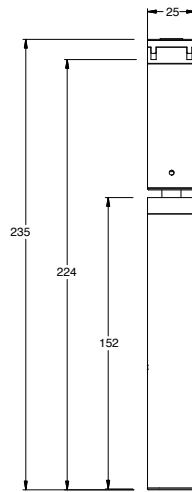
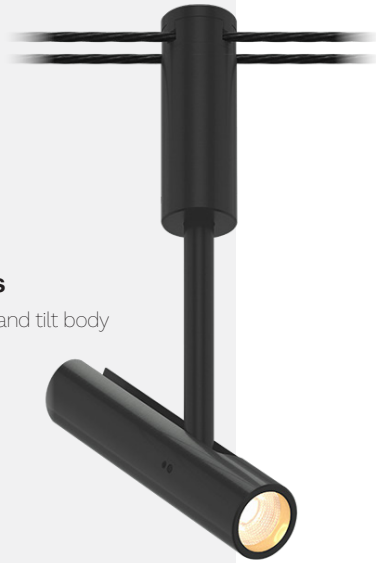

weight ~144g

**Pendant**  
suspended body

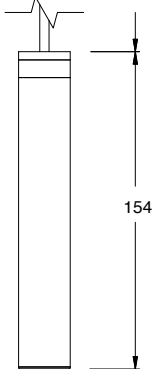
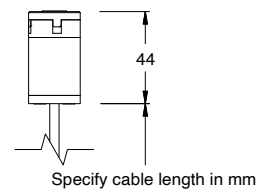

weight ~145g + 15g cable length per 5

Not to scale  
Dimensions in mm

# PHOTOMETRICS

Available in a range of distribution options from our Air family.

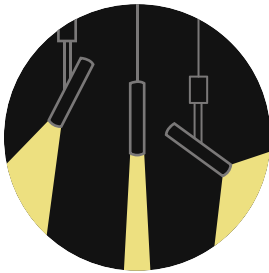

## Air Director

Precise, high uniformity and limitless flexibility, our Air Director series lets you sculpt with light with incredible control.

### Air Spots

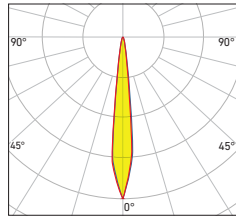

Spot

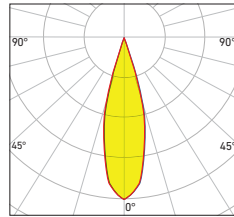

Narrow

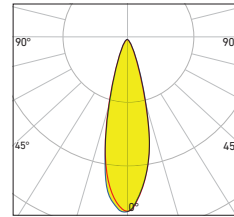

Medium

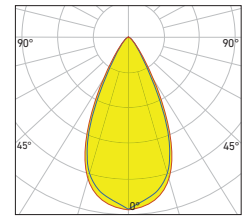

Wide

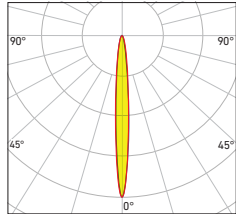

Snoot

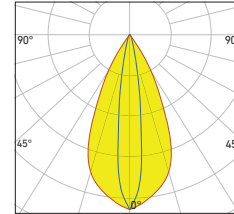

Oval

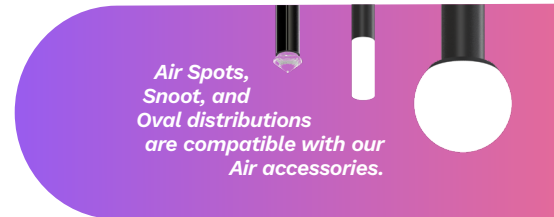

### Air Floods

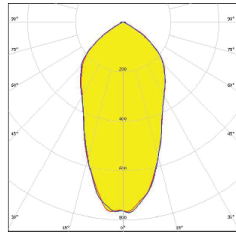

Flood Narrow

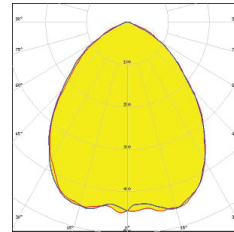

Flood Medium

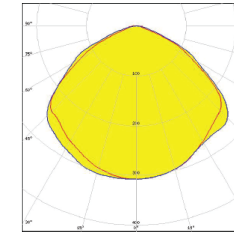

Flood Wide

### Air Batwings

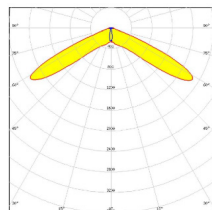

Batwing Line

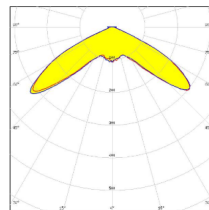

Batwing Square

### Air Street

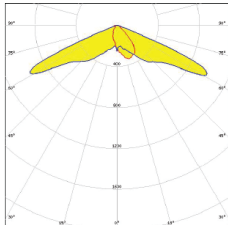

T1

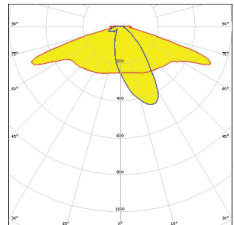

T2

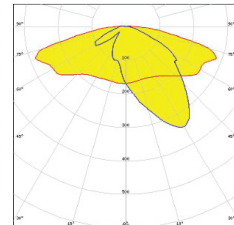

T3

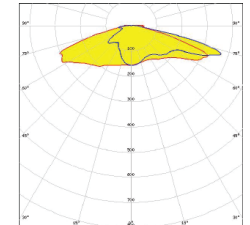

T4

## New Asymmetric Range: Air Street!

Our new asymmetric options are optimised for road and path lighting. Air Street enables extremely wide spacings while maintaining great uniformity and light levels.

## PHOTOMETRICS

Available in a range of distribution options from our Air family.

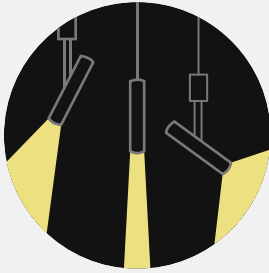

### Air Director

Precise, high uniformity and limitless flexibility, our Air Director series lets you sculpt with light with incredible control.

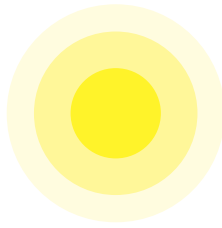

### Air Zoom

Flexible focus beam adjustment from narrow to wide (~10° to 60°)

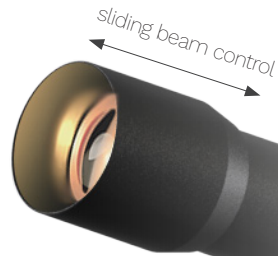

### Air Iris

Adjustable beam limiter from narrow to wide

Iris/aperture control lever



*Special beams Air Zoom (top right) and Air Iris (bottom right)*

## PHOTOMETRICS

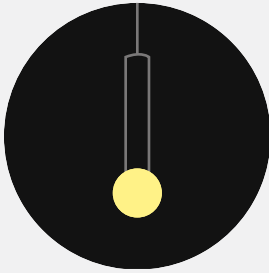

### Air Brilliant

Decorative and diffuse distribution options to set the mood and ambience.











Air Brilliant range available in various distributions for decorative and ambient effect.

DISTRIBUTION		DESCRIPTION
Air Diamond		Cut glass with high refractive effect producing a distinct star-shaped pattern and bright centre point
Air Prism		Cut glass with a soft yet defined kaleidoscope effect
Air Wand		Modern festoon dual lighting effect
Air Globe		Modern festoon lantern. Choose from Globe Closed, Globe Open, Globe Half, Globe Silver, Globe Frosted or Globe Glass.

## LED OPTIONS

Available in a range of white options (2200K-5700K CCT), Tunable White, or RGBW. Also available in 17 colours.

	2200K (22)		4000K (40)		Tunable White (TW)
	2700K (27)		5000K (50)		RGBW (RGBW)
	3000K (30)		5700K (57)		
	3500K (35)				

White <b>WT</b> Cool					White <b>WT</b> Neutral	White <b>WT</b> Warm	PhotoRed <b>HR</b> 650-670nm
Violet <b>VL</b> 400-420nm	RoyalBlue <b>RY</b> 450-460nm	Blue <b>BL</b> 460-475nm	Cyan <b>CY</b> 490-510nm	Green <b>GR</b> 520-535nm	Amber <b>AM</b> 585-595nm	Red-Orange <b>RO</b> 610-620nm	Red <b>RD</b> 620-630nm
	Phosphor <b>PB</b> Blue	Phosphor <b>PC</b> Cyan	Phosphor <b>PL</b> Lime	Phosphor <b>PA</b> Amber	Phosphor <b>PO</b> Red-Orange	Phosphor <b>PR</b> Red	
		Phosphor <b>PM</b> Mint	Phosphor <b>PY</b> Yellow				



## ACCESSORIES, FINISHES & EXTRA OPTIONS

Choose your finish, accessories and any additional options. LED Puck Air Catenary comes standard in anodised black marine grade aluminium with matching lens ring.

**Please note: Air Batwings, Air Floods and Air Street distributions are *not compatible* with Air accessories**











*Titlable wall mount accessory*

Up to  
**180°**

*Pole mounting options also available*

### New Air Projector Accessory!

Pair Air Pendant with our economical wall and pole mounting option, Air Projector.

FINISH / ACCESSORY		DESCRIPTION
Black Matte Body (Standard)		Anodised standard black marine grade aluminium
Black Lens Ring Finish (Standard)		Standard black lens ring finish
Gold Lens Ring Finish		Gold lens ring finish
Silver Lens Ring Finish		Silver lens ring finish
Painted Finish		Painted finish (please specify or contact us)
CRI 90+		CRI90+
Barn Doors		4 door adjustable barn doors
Air Lens Cover		Polycarbonate lens cover

**Spec Your  
LED Puck Air**  
*The Way You Want It!*

## HARDWARE

Mounting hardware sets are available for various mounting surface types. Sets come complete with Mount, Turnbuckles, blocks and grub screws. Cable and Drivers are available separately. See our Mounting Reference Guide for more details or contact your supplier.

### Total Installed horizontal loading:

40-50kg tensile force.

**Spec Your Mounting**  
See our Air Catenary Mounting Reference Sheets

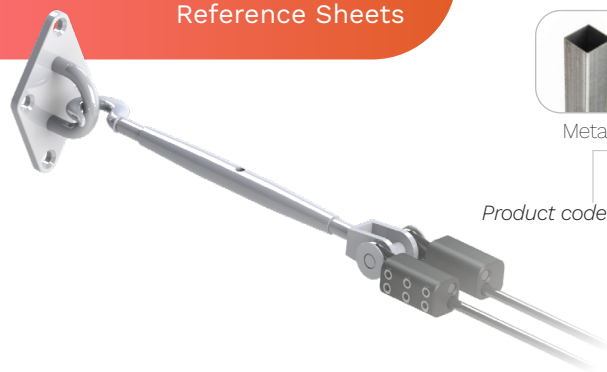

Product code



Masonry

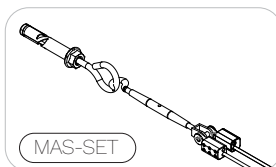

**Masonry Mount Set**  
For masonry surfaces



Timber

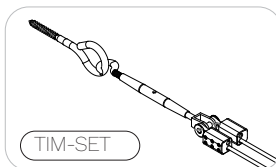

**Timber Mount Set**  
For timber surfaces



Metal

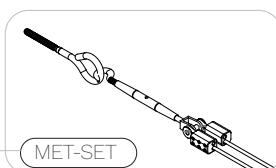

**Metal Mount Set**  
For metal surfaces

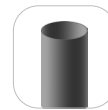

Pole\*

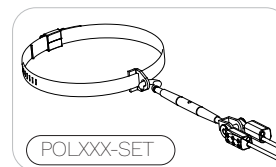

**Pole / Tree Mount Set**  
\*Remember to specify diameter. For example, the code P150 means one Pole/tree Mount Set to fit 150mm diameter.



Other\*

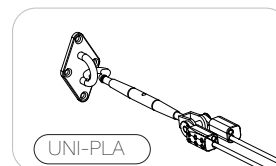

**Universal Plate Mount Set**  
Please contact us for advice.

Mounting hardware sets available for all surface types.

## CONNECTION

Air Catenary has a combined all-in-one twin cable suspension and power system, including Dim over power. There is no need for a separate power cable.

Air will conveniently mount and connect simultaneously via its screw on/off cap making repositioning simple.

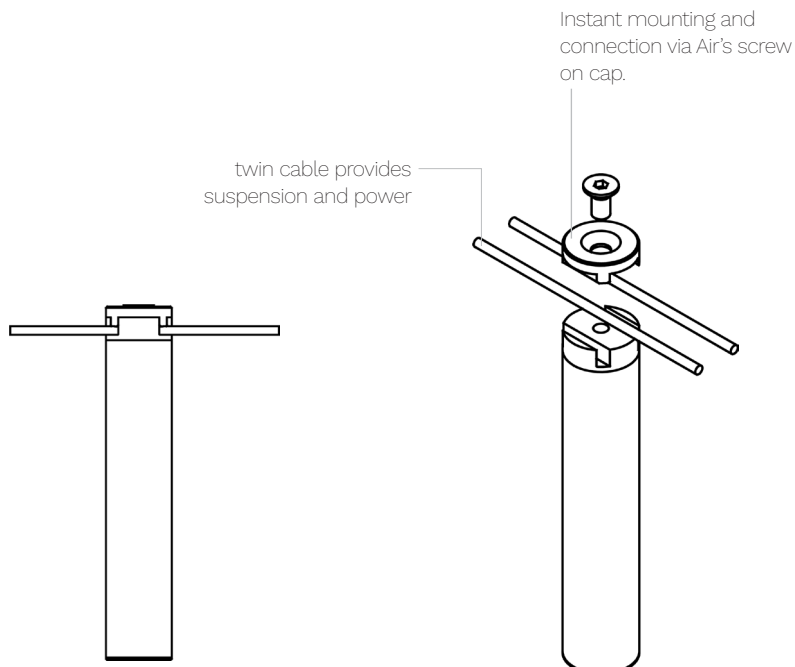

Luminaire connected (cap on)  
Side view

Luminaire disconnected (cap off)  
Isometric view.

\*Specifications are subject to change without notice.

Not to scale



## SPECIFY YOUR AIR CATENARY

Customise your Planet LED Puck Air to meet your specific requirements. Refer to the sample product code and accompanying product code table provided for guidance. For more detailed information, visit our website or contact your Planet Lighting supplier.

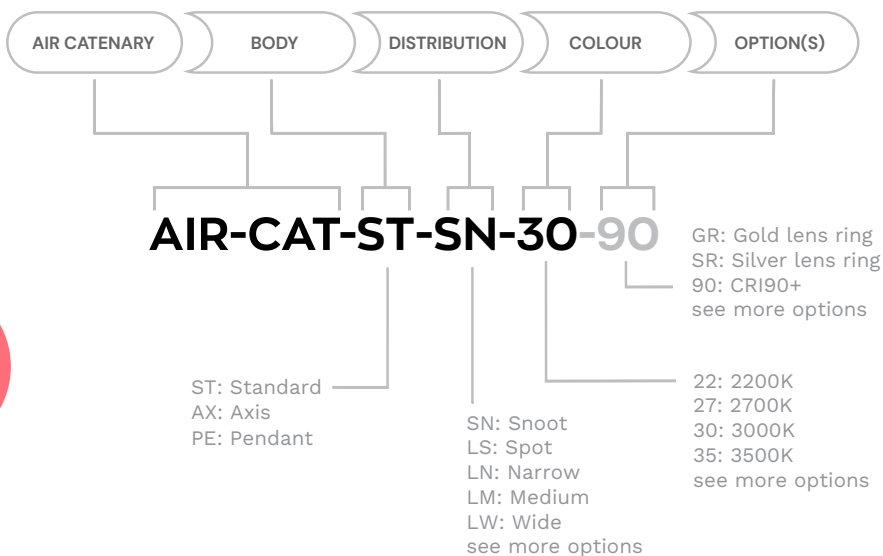

## Ask Us

Your success is important to us. Get in touch with your Planet LED Puck supplier today.

## PRODUCT CODES

### Body

ST	Standard body
AX	Axis body (pan and tilt)
PE	Pendant body

### Distribution

#### Air Director Range

SN	Snoot	Beam Limiter
LS	Spot	Extra Narrow Spot
LN	Narrow	Narrow Spot
LM	Medium	Medium Spot
LW	Wide	Wide Spot
FN	Flood Narrow	Narrow Flood
FM	Flood Medium	Medium Flood
FW	Flood Wide	Wide Flood

LO	Oval	Wide Elliptical
BS	Square	Batwing Square
BL	Line	Batwing Line
ZO	Zoom	Adjustable Focus
IR	Iris	Adjustable Limiter

#### Air Street Range

T1	T1	
T2	T2	
T3	T3	
T4	T4	

#### Air Brilliant Range

DI	Diamond
PR	Prism
WA	Wand
GO	Globe Open
GC	Globe Closed
GH	Globe Half
GS	Globe Silver
GF	Globe Frosted
GG	Globe Glass
	Custom Beam Angle (please enquire)

### Colour

22	2200K
27	2700K
30	3000K
35	3500K
40	4000K
50	5000K
57	5700K

VT	Violet
RY	Royal Blue
BL	Blue
PB	PC Blue
CY	Cyan
PC	PC Cyan
GR	Green
PM	PC Mint
PL	PC Lime
PY	PC Yellow

AM	Amber
PA	PC Amber
PO	PC Red-Orange
RO	Red-Orange
PR	PC Red
RD	Red
PH	Photo Red
RGBW	RGBW
TW	Tunable White
	Custom (please enquire)

### Custom Options

GR	Gold Lens Ring Finish
SR	Silver Lens Ring Finish
P	Painted Finish (please specify)
90	CRI 90+
BD	Barn Doors
LC	Air Lens Cover

\*Specifications are subject to change without notice.

